

OMX-07HMHM0001

4K HDR 4x4 HDMI Matrix Switcher with
Downscaling - 18Gbps

OPERATION MANUAL



Description:

The Ocean Matrix OMX-07HMHM0001 allows up to four HDMI source device connections to independently distribute any source to up to four connected HDMI displays. This HDMI 2.0 unit supports up to 4K@60Hz with flexible switching options for ease of use, as well as digital and analog audio extraction. The OMX-07HMHM0001 also supports mixed 4K & 1080p display outputs and features built-in downscaling for simultaneously displaying 4K content to a 4K monitor and 1080p content to a 1080p monitor.

Features:

- 4 x HDMI 2.0 Inputs
- 4 x HDMI 2.0/1.4 Outputs
- 4 x SPDIF Coaxial Audio outputs
- 4 x Analog Audio outputs
- Supports 4K@60Hz YUV 4:4:4
- Audio Sampling Rates up to 192kHz
- Supports HDR10, HLG, and Dolby Vision
- Supports IR, RS232 control, TCP/IP control, web GUI control, or Push Button control
- PCM2.0, Dolby True HD, DTS-HD Master Audio, and LPCM 7.1 Supported
- Supports Analog and SPDIF Audio Extraction
- 18Gbps Bandwidth
- HDCP 1.4 and 2.2 Compliant
- Built-in EDID Management and Learning

Specifications:

- Operating Temperature: 32 F to 104 F
- Max Resolution: 4K@60hz YUV 4:4:4
- Ethernet Port (IP Control): RJ45 Female
- IR Ext Port: 1 x 3.5mm Stereo Jack
- Bandwidth: 18 Gbps
- Dimensions (LxWxH): 8.5 x 5.1 x 1.3in
- Weight: 1.03lbs
- Power Consumption: 14W (Max)

Product Includes:

- 1 x 12V/2A DC Power Supply
- 1 x Remote Control
- 1 x IR Ext RX Cable
- 5 x Phoenix Plugs for RS232 Cable Termination & L/R Audio Termination
- 1 x Setup CD



Operation Controls and Functions:

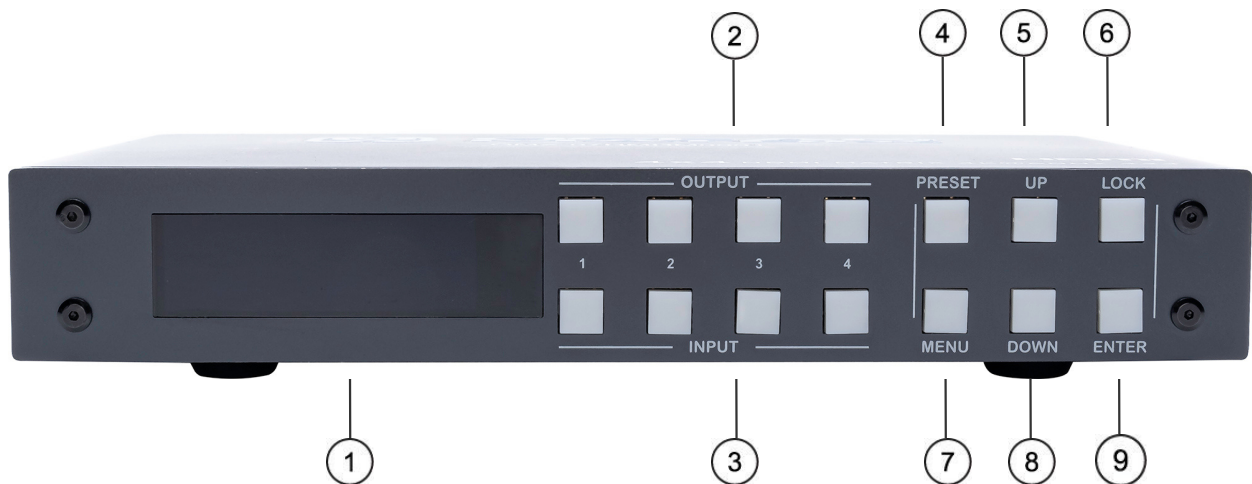

1. LCD Screen / IR Receiver Window

2. **Output 1-4:** Press to choose an output, press again to cancel. Press and hold to choose all outputs, press and hold again to cancel all.

3. **Input 1-4:** Press to choose one input, workable only if output is already chosen, press and hold to choose one input for all outputs.

4. **PRESET:** PRESS TO ACCESS PRESETS.

5. **UP Button**

6. **LOCK:** Press and hold to lock, repeat to unlock. When locked, all other buttons are not accessible.

7. **MENU:** Press to access main menu interface or return to the previous menu.

8. **DOWN Button**

9. **ENTER:** Press to confirm

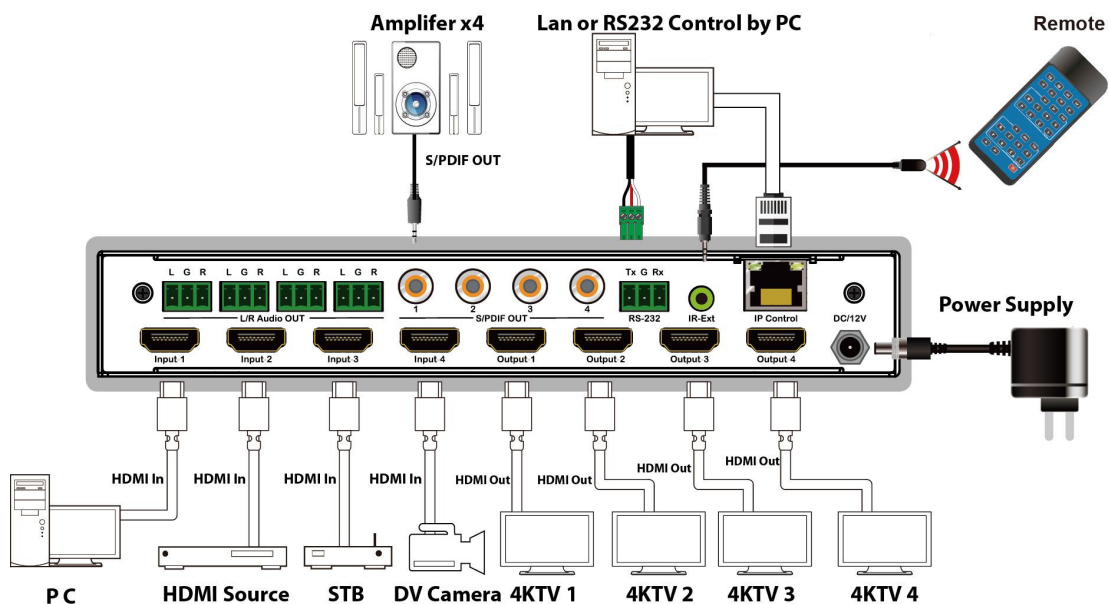

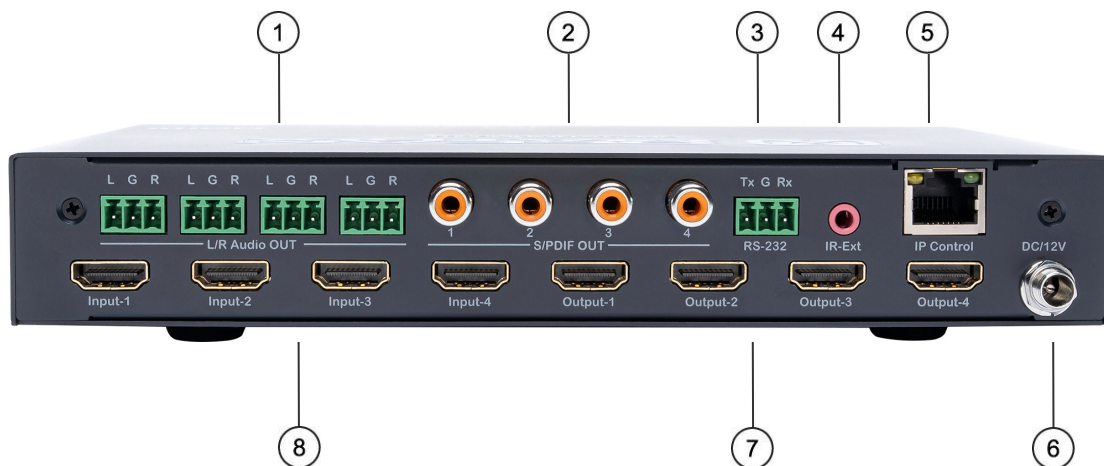

1. **Analog Audio Out**
2. **S/PDIF Audio Out**
3. **RS232 Control**
4. **IR-Ext**
5. **Ethernet Port**
6. **DC12V/2A Input**
7. **HDMI Output**
8. **HDMI Input**

Connecting and Operating:

1. Connect source devices to input ports of the matrix
2. Connect HDMI output ports to a TV or other HDMI devices
3. *Optional:* Connect RS232 cable from PC RS232 port
4. *Optional:* Connect an ethernet cable from the TCP/IP port on the matrix to a local network
5. Connect 12V power supply to DC power socket
6. Power on the matrix, HDMI sources and displays



Remote Control Description:

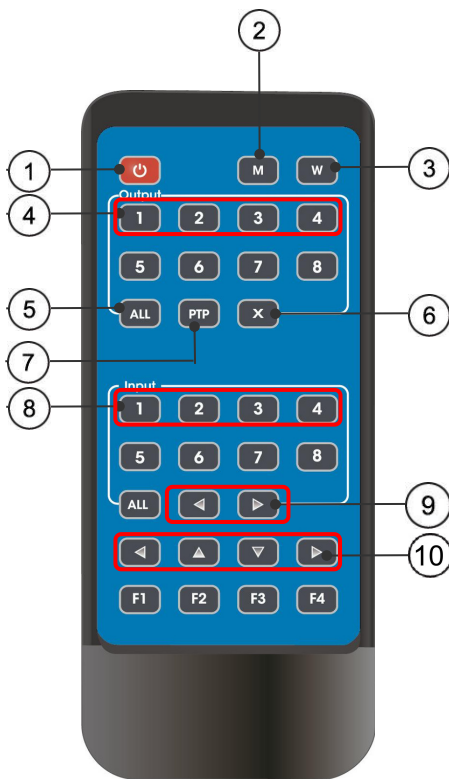

1. **Power On / Standby**
2. **M: Turn off the HDMI output audio**
3. **W: Lock remote control**
4. **Outputs 1-4**
5. **All: Selects all outputs**
6. **X: Turn off output channel**
7. **PTP: Mirror all inputs and outputs**
 - a. Ex. Input 1 to output 1, input 2 to output 2 etc..
8. **Inputs 1-4**
9. For switching inputs left and right
10. For switching inputs left and right, up and down

Note:

- **Power on / Standby:** press for standby mode, LCD screen will show "System Shutdown", HDMI output 5V will disconnect and TV without image. Press again to wake device, HDMI output will return to normal.
- **Video Switch:** output + input (ex. output 1 + input 2, switches output 1 to input 1)
- **Turn off HDMI Output Audio:** output + M (ex. output 1 + M, turn off output 1 audio)
- **Lock Remote Control:** press W to lock, press again to unlock
- **Turn off Output Channel:** output + x (ex. output 1 + X, output 1 turns screen black, output + X again, to return normal)
- **Switching Input Left and Right:** output + < or >; (ex. All + <, TV image will change according to the switching input and skip automatically if there is no input signal).



Panel Control Description:

Video Switch Operation:

Signal switching options includes 4 switching channels, which can be randomly configured as input/output according to requirements to form a 1x4 to 4x4 matrix. It can switch any input signal to 1 channel output or all channel outputs.

Operation format: "Output channel" + "input channel", or press and hold "input channel"

Output	1	2	3	4
Input	1	2	3	4

For example:

To switch output 1 to input 4:

Press output 1 + input 4 to complete switch

Note: Press output + input to switch; then press input button again to switch input (no need to repeatedly press output)

Video Control:

There are 2 sub-menus in video interface: 1: **Switching** 2: **On/Off**



Video Switching:

Operation:

1. Select "Video" in the main menu, press "ENTER" button
2. Press "up and down" button to choose "Switching"
3. Press "Enter" to enter the next sub-menu
4. Press the "up and down" button to select "Output 1 - 4" ("All" means all output, "Switching")
5. Press "Enter" to enter the next sub-menu
6. Press the "up and down" button to select input
7. Press "Enter" button to complete video switching



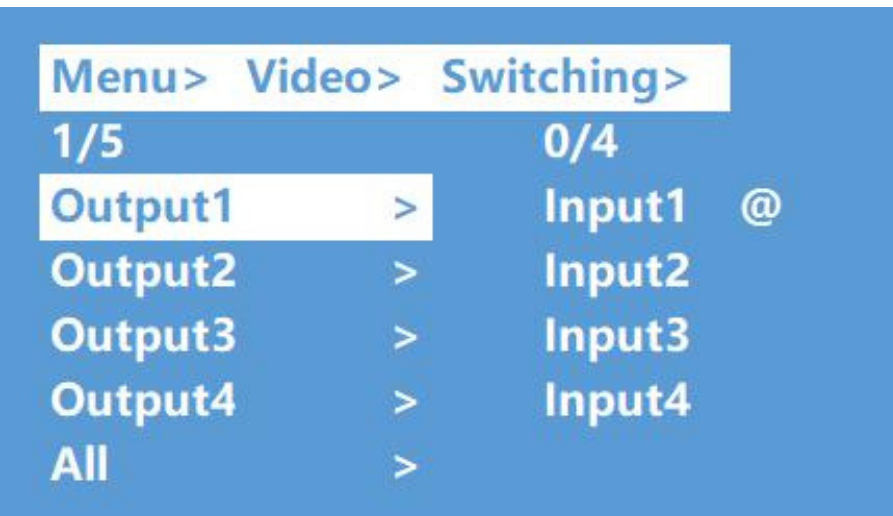
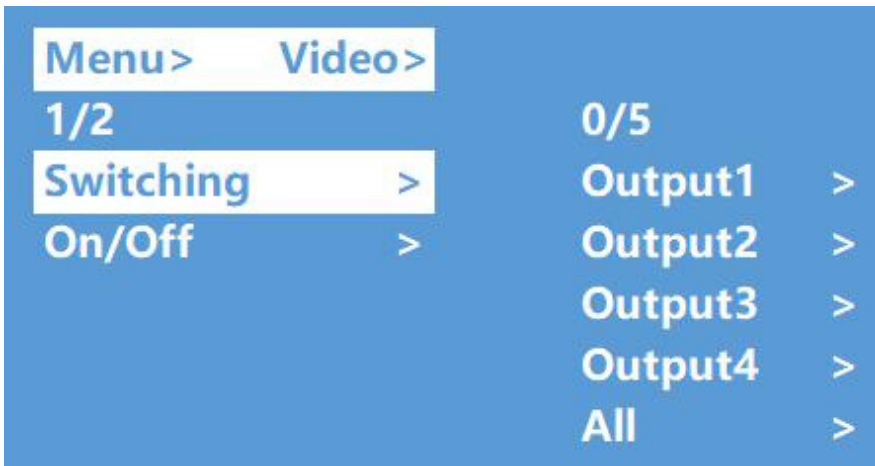

Output Switch Control:

Video output is open by default but you can open/close any output port, or open/close all output ports:

1. In the main menu, select "Video" and press "Enter" button
2. Press "up and down" button to select "On/Off"
3. Press "Enter" button to enter the next sub-menu
4. Press "up and down" button to select "output 1-4"
5. Press "Enter" to enter the next sub-menu
6. Select Output-HDMI 1-4, press "Enter" button to enter the next sub-menu
7. Press the "up and down" button to select "Off" or "On"
8. Press "Enter" button to confirm that the output port is open/closed





Audio Control Interface:

There are 2 sub-menus in audio control interface: Line out & De-Embed (both are default open)

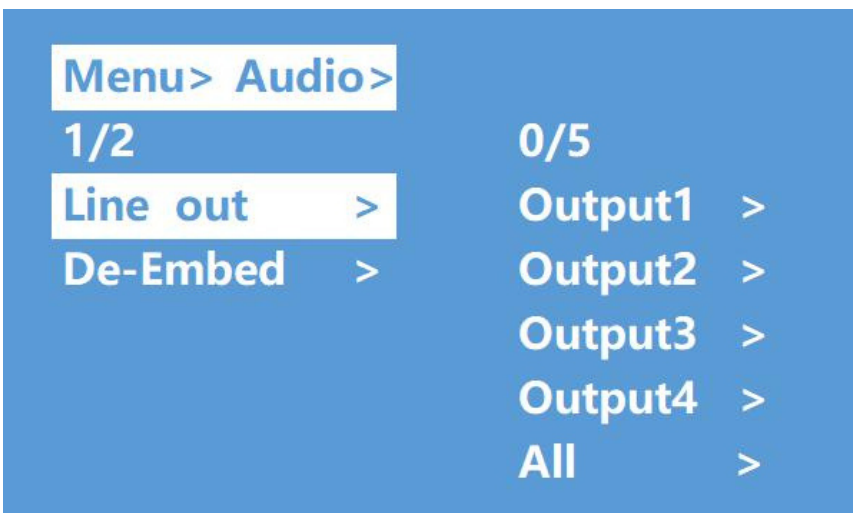

Switch Output Audio:

"Line out" means switch HDMI output audio, you are able to mute the TV from any one HDMI output channel

Operation:

1. Select "Audio" in main menu and press "Enter" button
2. Press "up and down" button to select "Line out", press "Enter" button, you are then able to select output 1-4 and all by pressing the "up and down" button. Press "Enter" button to choose "on" and "off"
3. Ex. to mute an HDMI connected to output1, press "Audio", "Enter", "Line Out", "Output1-HDMI1", "Off", "Enter"

Audio Extraction Control:

"De-Embed" to set the output audio for both analog and SPDIF audio, can select or mute any one audio channel

Operation:

1. Select "Audio" in the main menu and press "Enter" button
2. Press the "up and down" button to select "De-Embed", press "Enter" button, you are then able to select output 1-4 or all via pressing "up and down". Press the "Enter" button to choose "on" and "off"
3. Ex. to turn off audio extraction on HDMI output1 press "Audio", "Enter", "De-Embed", "Output1", "Off", you will then return to the upper menu after "Enter"

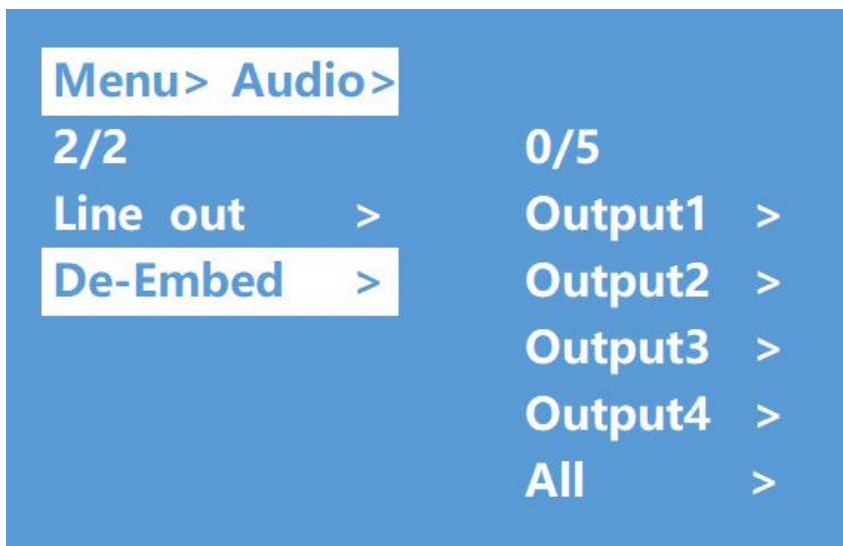

EDID Setting Interface:

EDID management: User EDID, build-in EDID, Copy EDID mode

The default EDID is "Default1"

Default1	4K60444-LPCM:2.0,HDR:HLG	Default2	4K60 420-LPCM: 2.0, HDR:None
Default3	4K30444-LPCM:2.0,HDR:None	Default4	1080P60 444-LPCM: 2.0, HDR:None



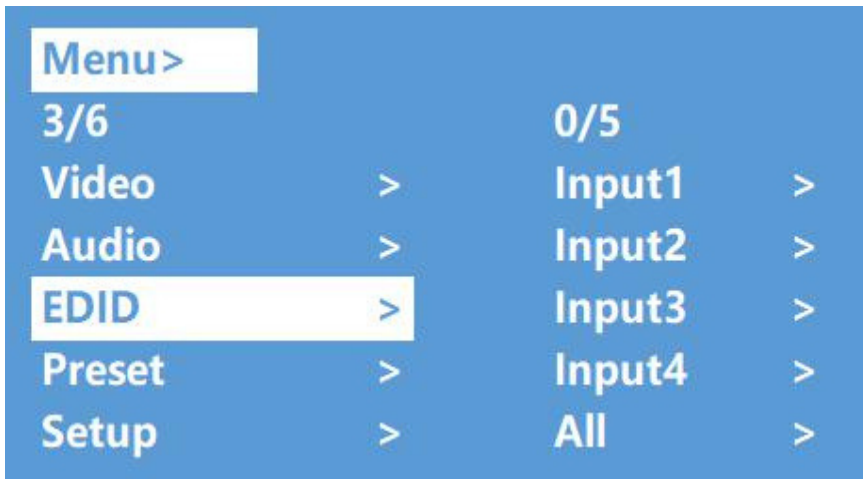

Ex. Switch default1 to output1:

Operation:

1. Select "EDID" in the main menu and press the "Enter" button
2. Press the "up and down" button to select "Input1"
3. Press the "Enter" button to enter the next sub-menu
4. Press the "up and down" button to select "Default1", press "Enter" to complete setting
5. Behind the selected EDID, it will show the max support resolution, audio format and audio channel

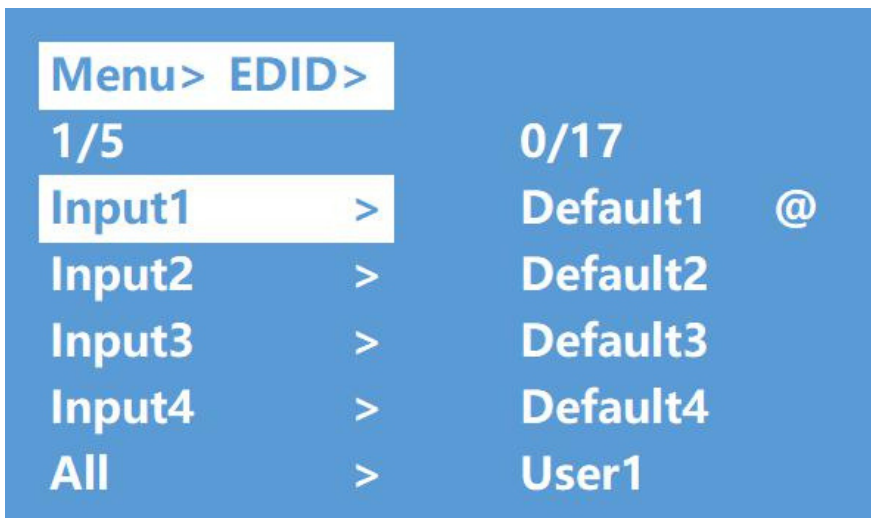



Preset Application:

The Preset interface can save the current video, audio, EDID, system settings, etc..., supports 8 different presets, can preset through the web, command, panel button, and recall
 Preset control interface has three sub-menus:

- Call Scene
- Save Scene
- Clear Scene

Operation:

1. Select "Preset" in the main menu and press "Enter" to enter the preset interface; you are able to call, save and clear preset
2. Save preset: select "Save" and any presets 1-8, then "Enter"
3. Call preset: Call, and any presets 1-8, then "Enter"
4. Clear preset: Clear, and any presets 1-8, then "Enter" (the saved preset will return to the default)

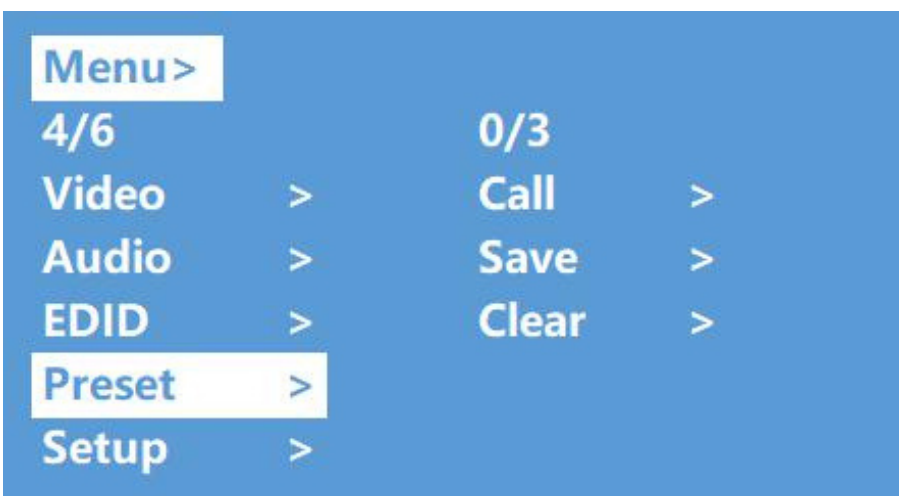



Setup Interface

Setup interface can set serial port baud rate, DHCP switch, device reboot and factory reset.

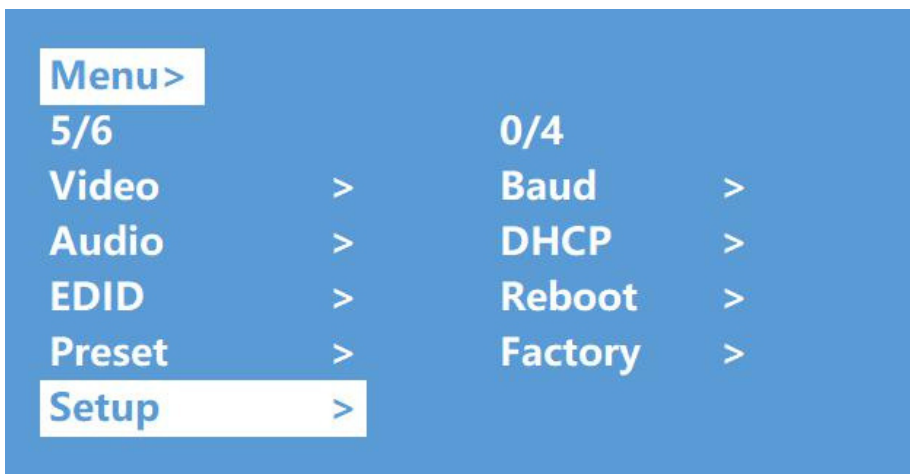

Baud Rate Setting:

Baud Rate Setting

4 options for baud rate setting: 9600, 19200, 57600, 115200. The default serial port is 115200

The below example is setting baud rate to 9600

Operation:

1. Select "Setup" in the main menu and press the "Enter" button
2. Press the "up and down" button to select the "Baud"
3. Press the "Enter" button to enter the next sub-menu
4. Press the "up and down" button to select "9600"
5. press "Enter" to complete setting

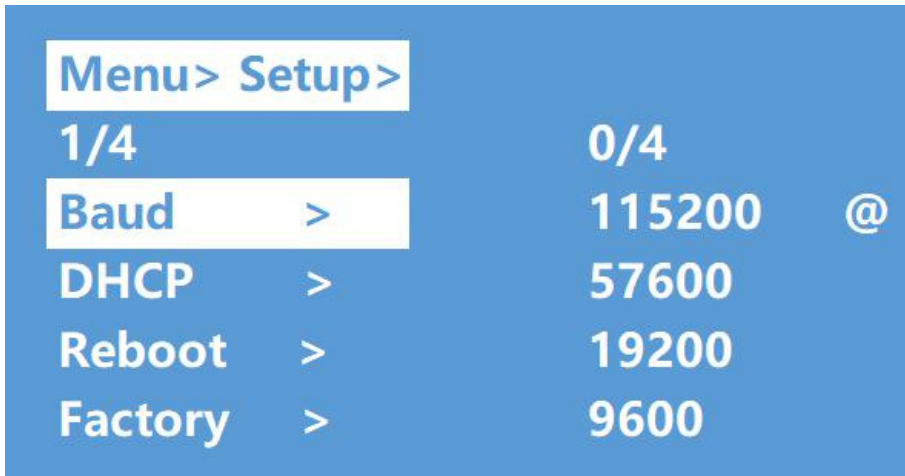

**DHCP Switch:**

DHCP On: dynamic IP address; DHCP Off: static IP address (default is DHCP off) DHCP on operation:

1. Select "Setup" in main menu and press the "Enter" button
2. Press the "up and down" button to select "DHCP" setting
3. Press "Enter" to enter the next sub-menu
4. Press the "up and down" button to select "On"
5. Press "Enter" to open DHCP to allocate an IP address automatically

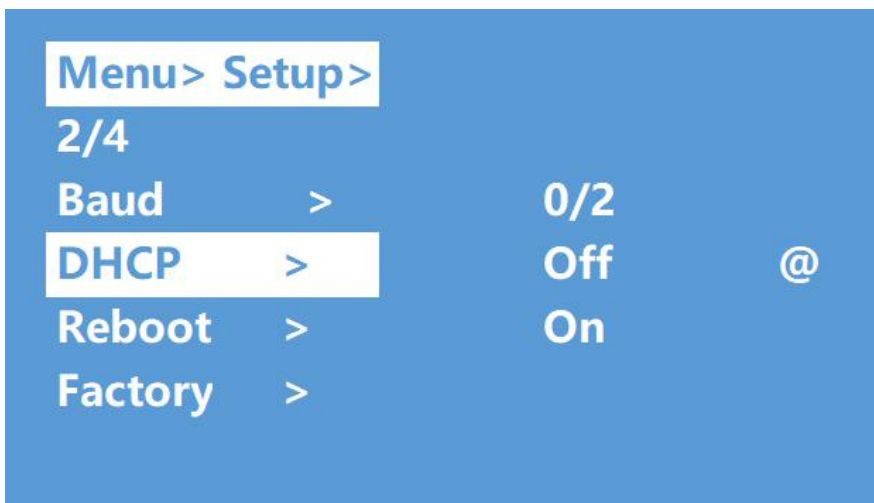
**Reboot:**

Reboot device, default is "NO".

Operation:

1. Select "Setup" in the main menu and press the "Enter" button
2. Press the "up and down" button to select "Reboot"
3. Press "Enter" to enter the next sub-menu
4. Press the "up and down" button to select "Yes"
5. Press "Enter" to complete rebooting the device



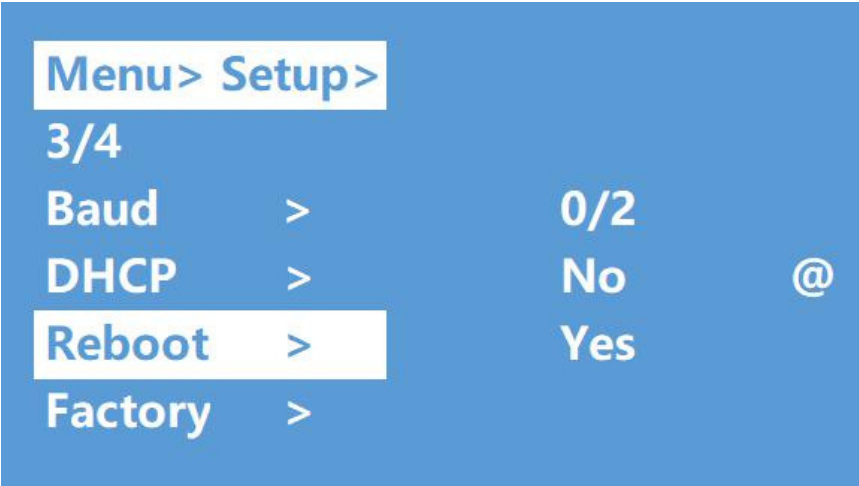

Factory Reset:

There are two factory settings:

- 1. Factory Common: factory reset for video switch, EDID, audio and settings (IP address can't be factory reset when under "common")
- 2. Factory All: factory set for video switch, EDID, audio, settings, presets and device name
 - a. Ex factory all operation:
 - i. Select "Setup" in the main menu and press the "Enter" button
 - ii. Press the the "up and down" button to select "Factory"
 - iii. Press "Enter" to enter the next sub-menu
 - iv. Press the "up and down" button to select "ALL" and press the "Enter" button
 - v. Press the "up and down" button to select "Yes" and press thr "Enter" button

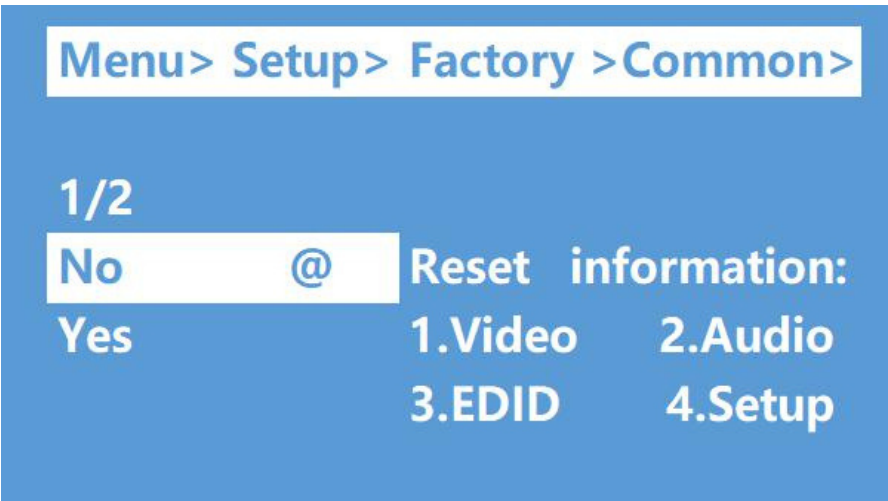



Query Information Interface:

System interface: query company name, device name and version information

IP interface: query device IP address, MAC address and DHCP status

Operation:

1. Select "INFO" in main menu and press "Enter" button
2. Press the "up and down" button to select "System" or "IP", bottom color will turn white when selected
3. Press "Enter" to enter the next sub-menu, then you are able to query device information

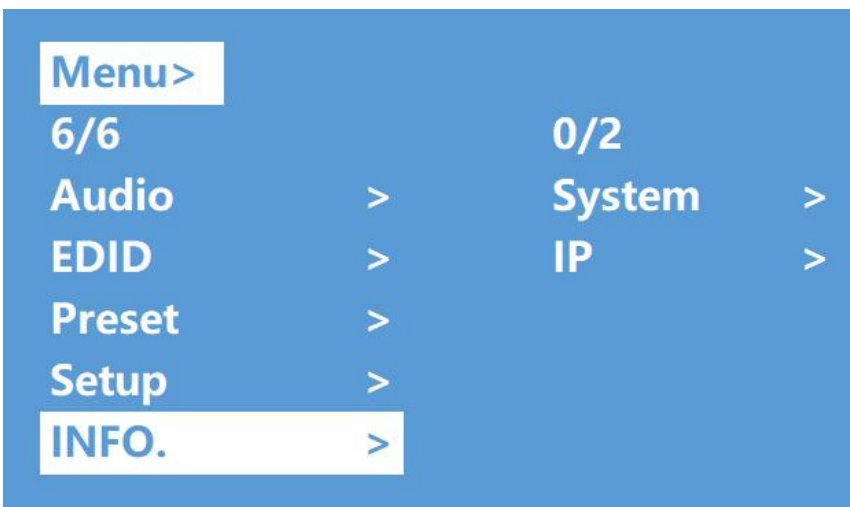

Menu>INFO. >

2/2

System

DHCP Off

IP

IP 192 . 168 . 1 . 168

MASK 252 . 255 . 255 . 0

WG 192 . 168 . 1 . 1

MAC 0008-DC40-7454



9. RS232 Control

- 9.1 Open CommUart Assistant.
- 9.2 Comport setting:



Choose correct COM port that connect to PC in parameter configuration area

Baud Rate:	115200 bps(Default)
Parity:	None
Data Bit:	8bit
Stop Bit:	1bit

9.3 Enter Port Command in Send options.

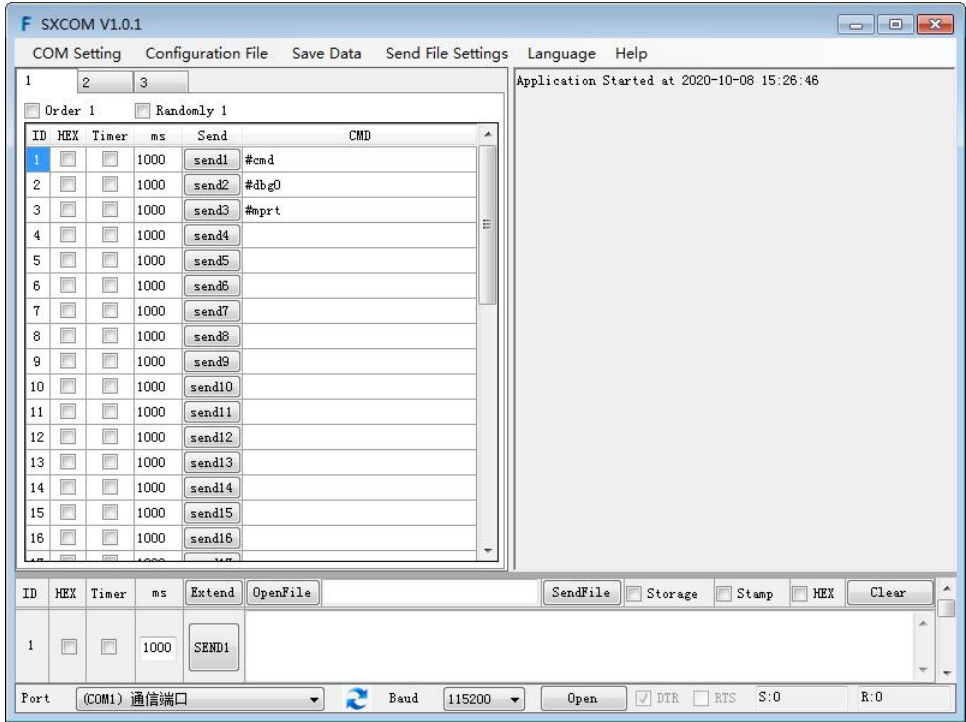

9.4.Command List

- 1).All commands start with “#”
- 2).“_” the underline cannot omit.
- 3) Command head,Parameter and target need to add one “SPACE”.

The following table is only an example.Please refer to the list of instructions.

Type	Format	Value	Regulation
Command head	#cmd	without	
Explain	Can be used to search command,after receiving command, the system will feedback all open command format fields		
Example1	#cmd		
	Search all open command		

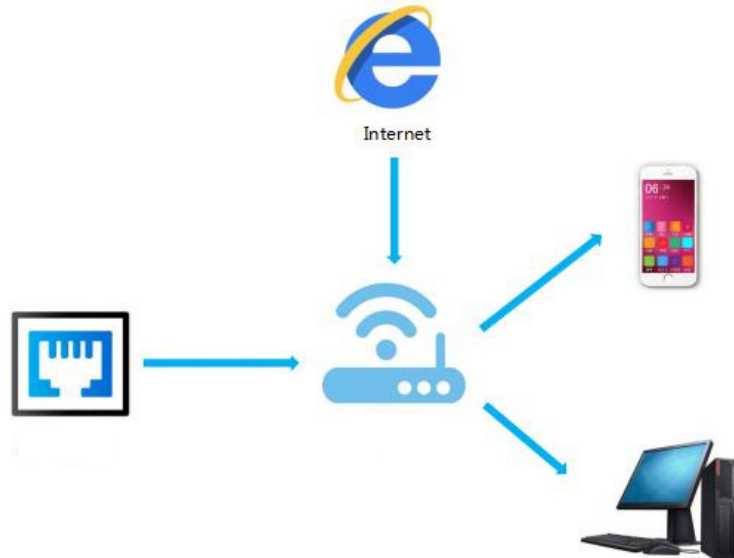

Web Control:**Change IP Address of PC:**

Before configuring the device through the website, it is necessary to configure the IP address of the computer configured with the device (mainly to ensure that the computer and the device are set in the same network segment).

- 1). Open the network control center and set the computer's IP address:
- 2). Choose to use Static IP, with the IP address set to 196.168.1.x (x ranges from 0 to 254, but cannot be consistent with the device's IP address),
- 3). Subnet mask set to 255.255.255.0
- 4). Gateway set to 192.168.1.1

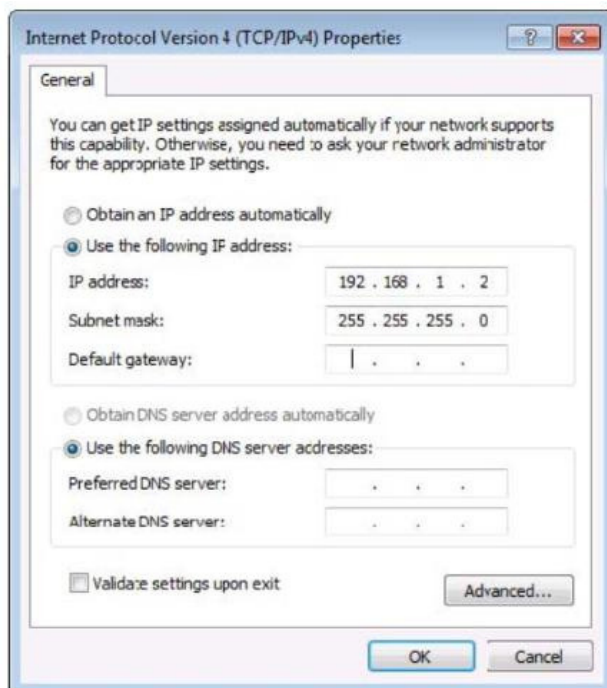

Log in by Browser:

Default IP address for log-in: 192.168.1.168

Type in user name and password (default user name: admin; default password: 123456)

Note: it is suggested to use newer versions of Google, firefox, etc.. for better compatibility.

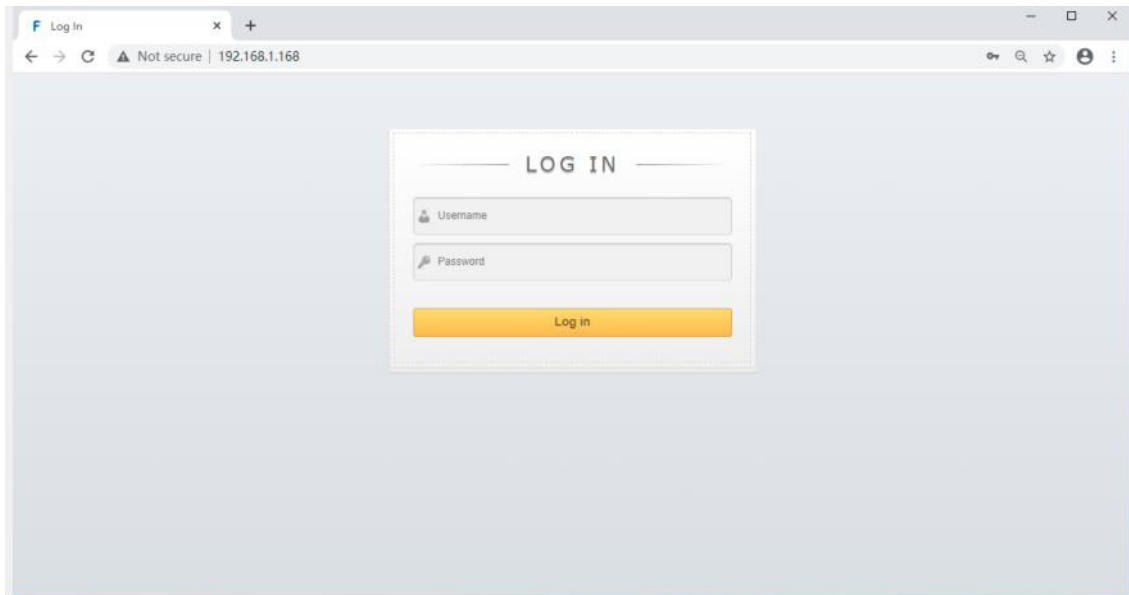

Video interface:

1. Output: 01 >> 02, 01 means input, 02 means output, all means all output

Operation steps:

Click 01 >> 01 or All, then click input 01~04

Ex: Switching input 1 to output 4; Click "04 >> 04" first, then click "01"

2. Input: 01~04 means HDMI input 1~4

3. OFF: Close output channel, click "OFF" to close output channel; Click "ON" to close this function. The default is "OFF"

4. Store: preset1~preset8. Recall: call the preset; Save: save the preset

Operation steps:

1) Call preset: preset1 + Recall, call preset1

2) Save preset: preset2 + Recall, save preset2

Modify Port Name:

1. Click to choose the input or output port, rename in input box, then click save & exit

2. Click to choose preset, rename in input box, then click save & exit

Note: Rename limit: 1-15 characters



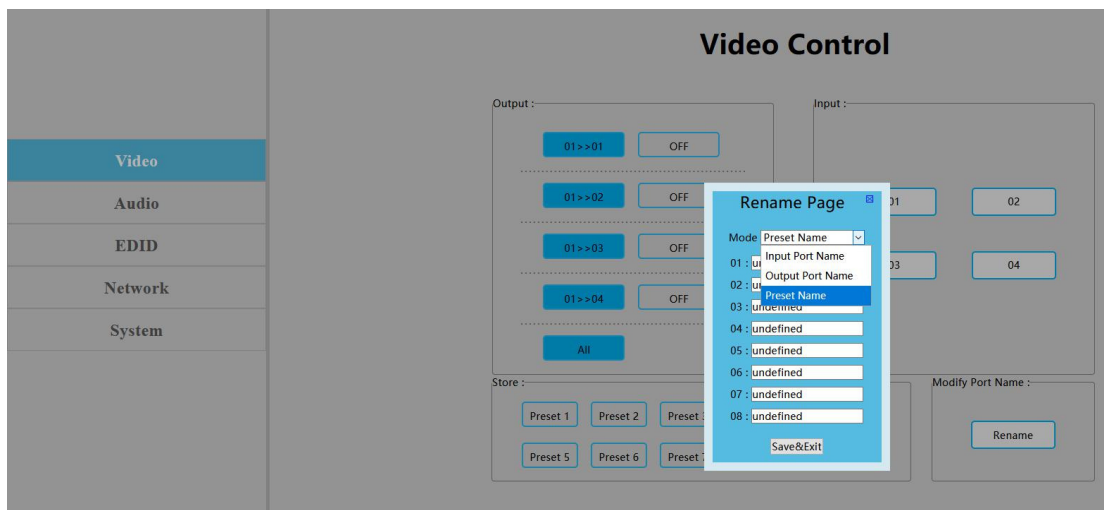
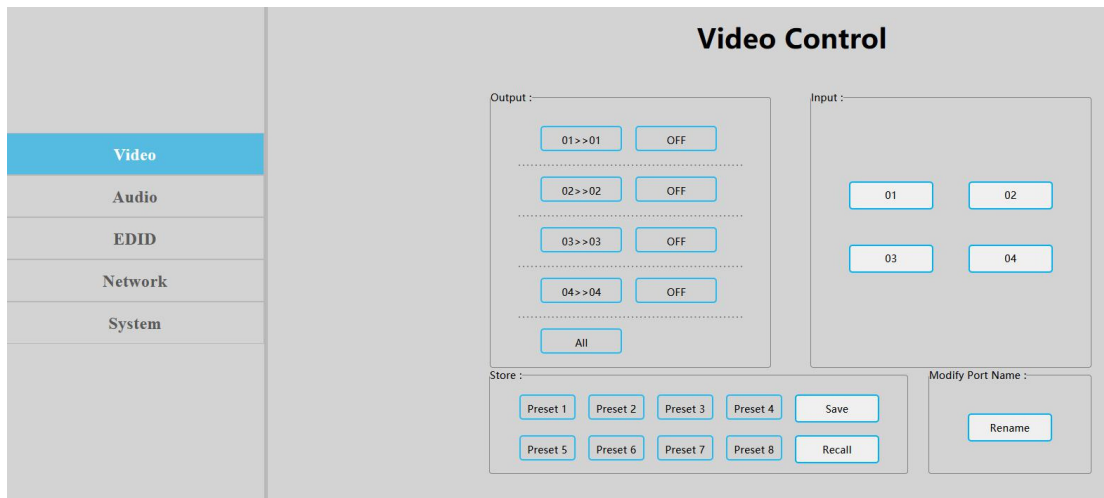

Audio Interface:

1. Click output1-4 HDMI: Turn off HDMI output audio;

Operation:

- Ex: Turn off audio on the unit connected to HDMI output1 (TV)
- Click output1 HDMI, color will change on the TV, will only display video (no audio)
- Re-click to turn on audio

2. Click output1-4 De-Embed: turn off audio extraction function, also turn off SPDIF and analog audio at the same time.

Operation:

- Ex: Turn off HDMI output1 audio extraction
- Click output1 De-Embed, color will change and audio for analog and SPDIF out will turn off
- Re-click to turn on audio



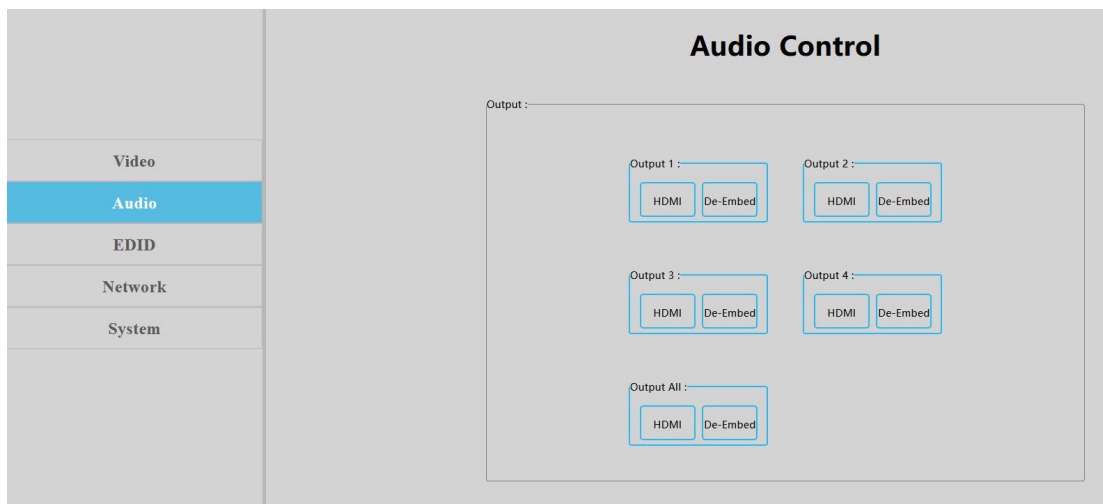

EDID Interface:

- 1. Input: 00>> Input1, 00~16: EDID number, Input1~4: HDMI input1~4
- 2. Ouput: 00~03: Default EDID, 04~07: User EDID, 08~11: Copy EDID, 12~15: Input EDID, 16: Temp EDID, refer to below for more details:

00	4K60 444-LPCM: 2.0, HDR:HLG	01	4K60 420-LPCM: 2.0, HDR:None
02	4K30 444-LPCM: 2.0, HDR:None	03	1080P60 444-LPCM: 2.0, HDR:None
04	User1	05	User2
06	User3	07	User3
08	Copy HDMI out1	09	Copy HDMI out2
10	Copy HDMI out3	11	Copy HDMI out4
12	Copy input1	13	Copy input2
14	Copy input3	15	Copy input4
16	Default is empty, need save EDID to device to take effect,don' t support power-off memory		

- 1. EDID information: show EDID here: click "00>> Input1" or 00: "Default1", will show resolution, audio, audio channel, HDR and serial number
- 2. Edit user EDID: Click "Edit User EDID", choose default, user, copy, input EDID on "EDID Edit Page" to save User 1-4, support power-off memory

Operation:

- 1. HDMI input1 use second default EDID; click "00>>Input1", then click "01: Default2"
- 2. Save copy HDMI out1 to User1: choose "default1" in "EDID Edit Page", then choose "User1" and click "Set" to finish



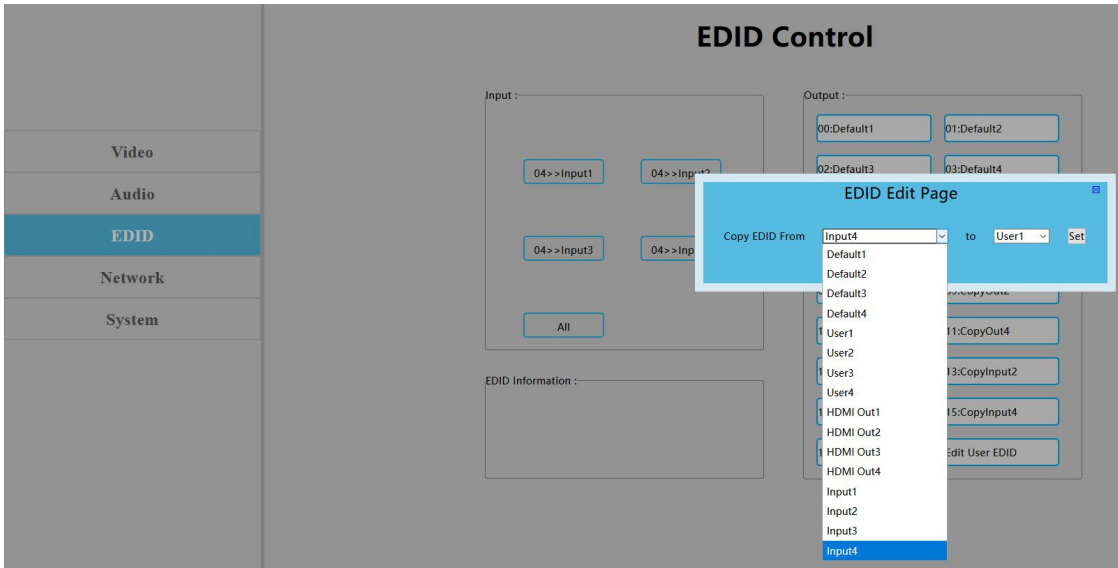

Network Interface:

MAC address can not be modified, for display only.

Static IP: Click DHCP switch (DHCP Off), you can modify IP address, then click “Apply” button, it will then countdown. If device IP address is the same as client IP, it will re-login into the web interface. If unable to refresh automatically, then resubmit form manually

Dynamic IP: Click DHCP switch (DHCP On), IP address is assigned by router and will turn to grey, can not be modified, but can display current IP address information.

IP address / Net Mask address / Gate Way address can only be modified when DHCP is Off

Default IP Address: 192.168.1.168



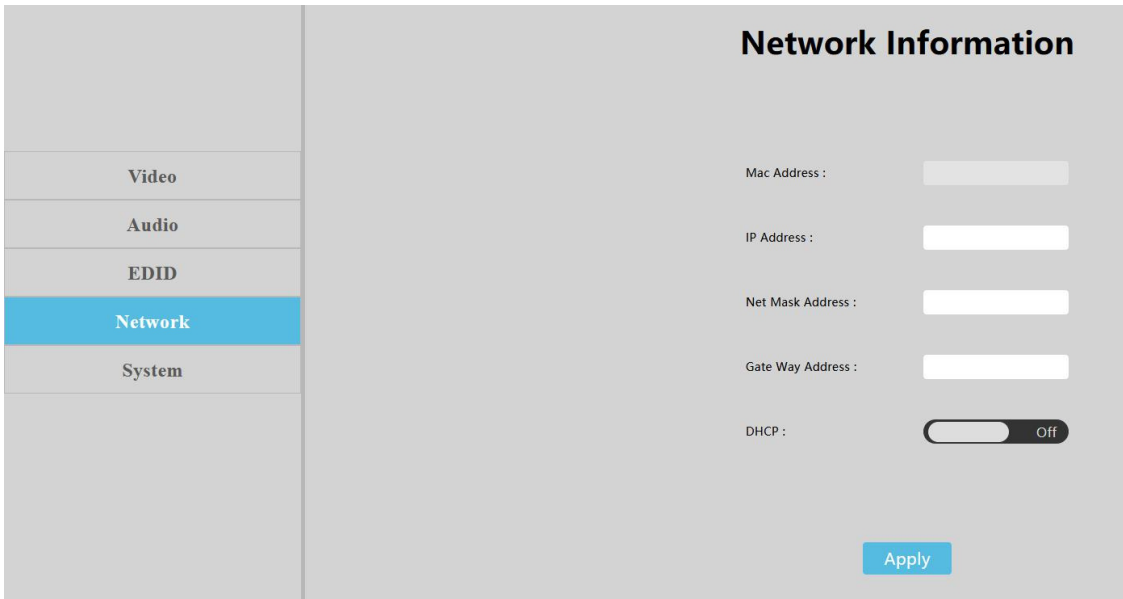

System Setting Interface:

1. System Setting:

Reboot: Click to reboot device

Factory Common: Click to reset device for partial function

Factory All: Click to reset device totally

“Reboot” will not clear user parameter; “Factory Common” will not clear Network and Preset parameter; “Factory all” will reset to default totally

2.Change Password: Change user name and password, then click”Apply”.

Note:The user name and password, only supports 6~15 characters

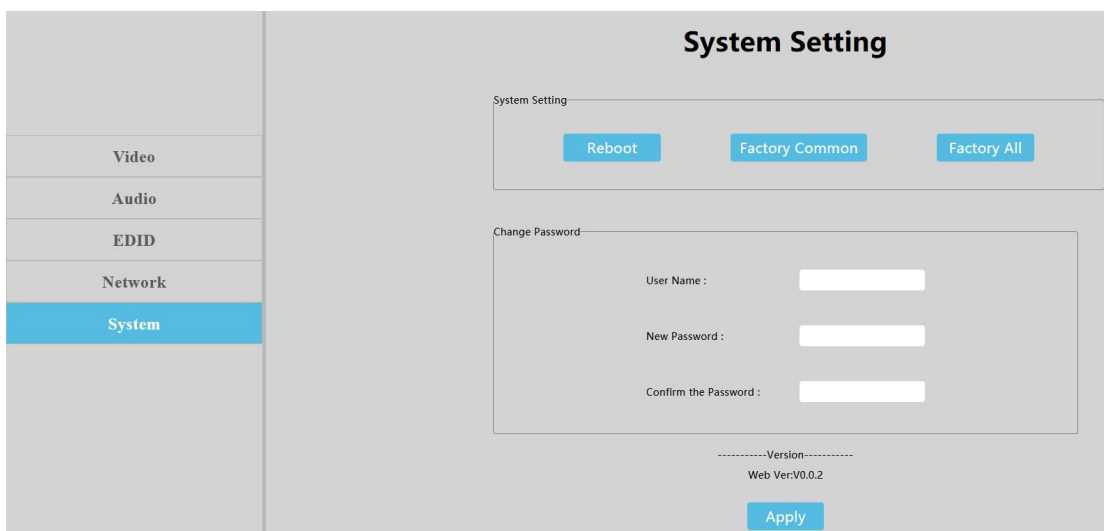

PRODUCT SERVICE

Damage requiring service:

- The unit should be serviced by qualified service personnel if:
 - (a) The DC power supply cord or AC adaptor has been damaged
 - (b) Objects or liquids have gotten into the unit
 - (c) The unit has been exposed to rain
 - (d) The unit does not operate normally or exhibits a marked change in performance; The unit has been dropped or the cabinet is damaged.
- (2) Servicing Personnel: Do not attempt to service the unit beyond that described in these operating instructions. Refer all other servicing to authorized servicing personnel.
- (3) Replacement parts: When parts need replacing ensure the servicer uses parts specified by the manufacturer. Unauthorized substitutes may result in fire, electric shock, or other hazards.
- (4) Safety check: After repairs or service, ask the servicer to perform safety checks to confirm that the unit is in proper working condition.

SAFETY PRECAUTIONS

Please read all instructions before attempting to unpack, install or operate this equipment and before connecting the power supply.

Please keep the following in mind as you unpack and install the unit:

- Always follow basic safety precautions to reduce the risk of fire, electrical shock and injury to persons.
- To prevent fire or shock hazard, do not expose the unit to rain, moisture or install this product near water.
- Never spill liquid of any kind on or into this product.
- Never push an object of any kind into this product through any openings or empty slots in the unit, as you may damage parts inside the unit.
- Do not attach the power supply cabling to building surfaces.
- Use only the supplied power supply unit (PSU). Do not use the PSU if it is damaged.
- Do not allow anything to rest on the power cabling or allow any weight to be placed upon it or any person walk on it.
- To protect the unit from overheating, do not block any vents or openings in the unit housing that provide ventilation and allow for sufficient space for air to circulate around the unit

WARRANTY

1 Year



812 Kings Highway | Saugerties, NY 12477 | 845-246-7500 | www.oceanmatrix.com
100% Employee Owned Division of Tower Products Incorporated